



Display Cabinet with swing glass door

The Cabinet with flip door is available in two widths, 78 cm and 58 cm, and one depth, 30 cm. The height of the cabinet is 42 cm. The cabinet fits together with all 30 cm deep wire and plex panels from String® System. The cabinet consists of one adjustable inner shelf. The internal dimensions are w75/w54 x d26 x h38 cm. The cabinet is delivered unassembled.

About the designer – String Furniture

For a number of years, the production of String® was non-existing. The years passed by and it was not until 2004 the brand revived. It was during this time String®, as we know the brand today, took form. The assortment was carefully revised and new features for the shelving system were designed and developed. The updated and now modern shelving system was here to stay! Over a night, String® was once again considered an obvious part of the timeless Scandinavian design style.

Product dimensions

W: 58 cm D: 30 cm H: 42 cm

Package dimensions

W: 61 cm D: 40 cm H: 9 cm

Weight: 14,2 kg

Delivered flat-packed, assembly needed.

Weight recommendation

25 kg evenly spread across one shelf.

Materials and colours

Lacquered MDF or veneered particleboard.

Glass door and glass shelf.

Production

Made in Sweden.





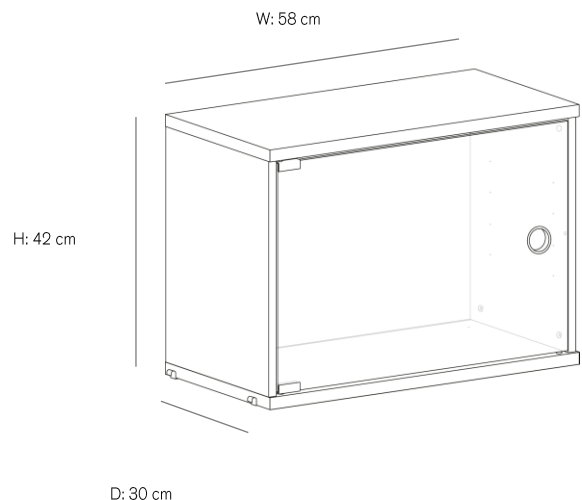

Sustainability

The product is made from veneer with fiber board or MDF. The fiber board is made from 90% recycled material. The brackets are made from zinc (with 14% recycled material) and the handle is made from stainless steel, which can both be recycled. The product is easy to disassemble, to exchange spare parts. The glass is a safety glass.

Care and maintenance

Wipe the surface with a damp cloth. Then rub dry with a clean, dry cloth. Remove stains with detergents that do not contain abrasives. Never use steel wool.



	White NCS S 0500-N
	Beige NCS S 3005-Y20R
	Grey NCS S 4500-N
	Blackstained ash
	Oak
	Ash
	Walnut